

Mandatory Disclosure

	Mandatory Disclosure	Updated on 4 th May 2010
1	AICTE File No.	765-65-202(E)/ET/95
	Date & Period of last approval	07 th August 2008
2	Name of the Institution	Beant College of Engg. & Technology
	Address of the Institution	Post Box No 13 Gurdaspur-Pathankot Road Gurdaspur Punjab-143521
	City & Pin Code	Gurdaspur -143521
	State / UT	Punjab
	Longitude & Latitude	75.26E & 32.03N
	Phone number with STD code	01874-221463
	FAX number with STD code	01874-221464
	Office hours at the Institution	8
	Academic hours at the Institution	8
	Email	pbcetgsp@gmail.com
	Website	www.bcetgsp.ac.in
	Nearest Railway Station (dist in Km)	5
	Nearest Airport (dist in Km)	95
3	Type of Institution	Government
	Category (1) of the Institution	Non Minority
	Category (2) of the Institution	Co-Educational
4	Name of the organization running the Institution	State Government
	Type of the organization	Society
	Address of the organization	Beant College of Engg. & Technology
	Registered with	Punjab Government
	Registration date	6 th December 1993
	Website of the organization:	www.bcetgsp.ac.in
5	Name of the affiliating University:	Punjab Technical University
	Address:	Jalandhar, Punjab
	Website:	www.ptu.ac.in
	Latest affiliation period	1 Year
6	Name of Principal :	Dr Dial Chand
	Exact Designation:	Professor
	Phone number with STD code	01874-221464
	FAX number with STD code	01874-221463
	Email	pbcetgsp@gmail.com

	Highest Degree	PhD
	Field of specialization	Elastic & Magneto Thermo-Elastic Media
7	Governing Board Members:	Technical Education Minister, Punjab
		Secretary to the Government of Punjab, Department of Finance
		Secretary to the Government of Punjab, Department of Technical Education
		Secretary to the Government of Punjab, Department of Science and Technology, & Environment
		Director, Technical Education, Punjab
		One MLA. holding a Technical Degree
		Not more than two members from amongst Govt. of India/All India Institutions
		Any other two members whose experience is considered relevant to the cause of technical education of management of the colleges. These could also be chosen out of Senior State Govt. Officers
		The Vice-Chancellor of the affiliating University of his nominee (Earlier it was GNDU, Amritsar)
		Industrial/Technologist in the region to be nominated by the State Government
		Industrialist/Technologist in the region to be nominated by the State Government
		Nominee of the University Grants Commission
		One representative of the faculty from amongst Professors for one year to be nominated by the Chairperson Board of Governors
		One representative from other faculty for one year to be nominated by the Chairperson Board of Governors
		Chairman/Chairperson, Punjab State Board of Technical Education & Industrial Training, Punjab
		Principal of the Beant College of Engineering & Technology, Gurdaspur
	Frequency of meeting & date of last meeting	Twice a Year & 3 rd March 2008
8	Academic Advisory Body	Board of Studies (B.O.S.) constituted by PTU, Jalandhar to formulate/revise the B.Tech and M.Tech Courses Curriculum.
	Frequency of meeting & date of last meeting	Twice a year. However, the meetings for the academic council are held quarterly or as demanded as per need of the hour.

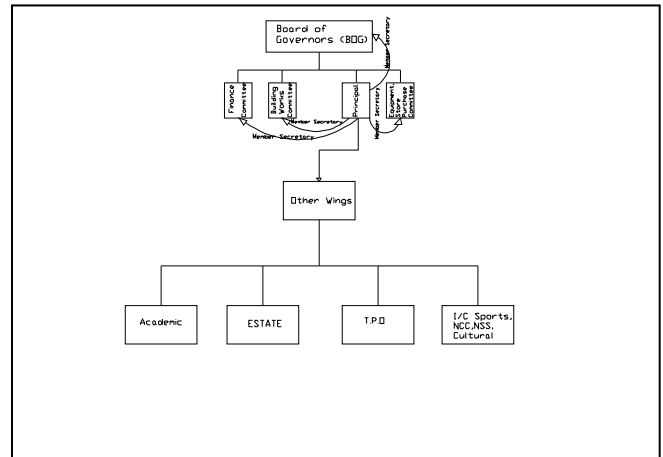

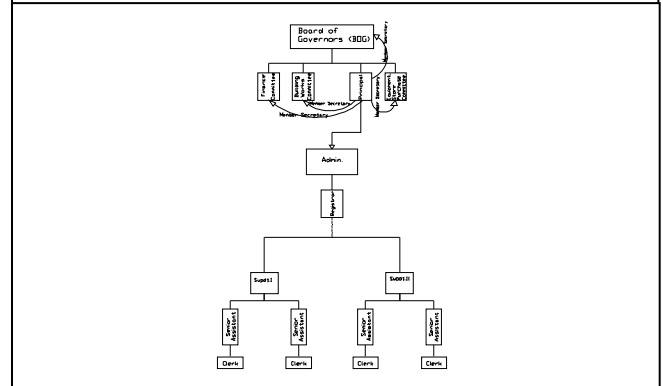
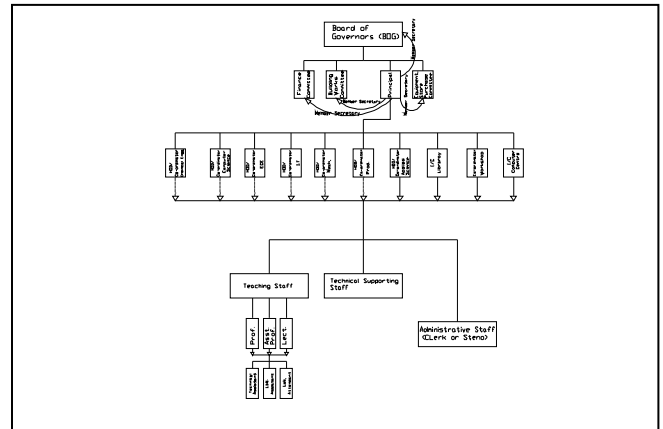
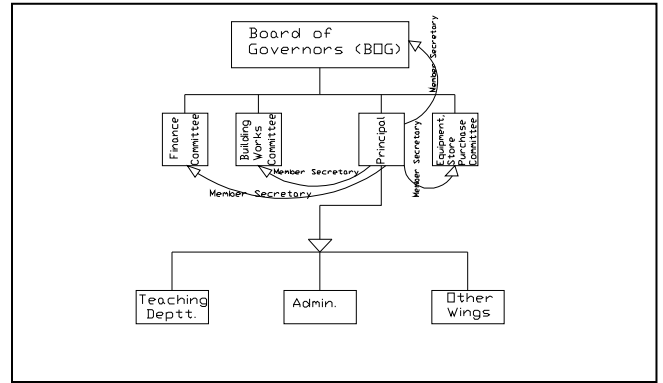

10	Student feedback mechanism on Institutional Governance/faculty performance	<p style="text-align: center;">BEANT COLLEGE OF ENGINEERING & TECHNOLOGY GURDASPUR</p> <p style="text-align: center;">STUDENT'S FEEDBACK FORM</p> <p>Session _____ Class _____ Subject _____ Name of Teacher _____ Note: (1) Please do not disclose your identity anywhere on this form (2) Please tick mark in the appropriate column to give your response.</p> <p>(I) Teaching Attributes:-</p> <table border="1" style="width: 100%; border-collapse: collapse;"> <thead> <tr> <th>Sr. No.</th> <th>Attribute</th> <th>Excellent</th> <th>V_Good</th> <th>Good</th> <th>Fair</th> <th>Poor</th> </tr> </thead> <tbody> <tr><td>1</td><td>Knowledge of the Subject</td><td></td><td></td><td></td><td></td><td></td></tr> <tr><td>2</td><td>Way of Teaching / Method of Expression</td><td></td><td></td><td></td><td></td><td></td></tr> <tr><td>3</td><td>Oral Communication in Class</td><td></td><td></td><td></td><td></td><td></td></tr> <tr><td>4</td><td>Interaction with students in Tutorial class</td><td></td><td></td><td></td><td></td><td></td></tr> <tr><td>5</td><td>Experimental skills in Lab Class</td><td></td><td></td><td></td><td></td><td></td></tr> <tr><td>6</td><td>Use of Teaching Aids</td><td></td><td></td><td></td><td></td><td></td></tr> <tr><td>7</td><td>Punctuality in class</td><td></td><td></td><td></td><td></td><td></td></tr> <tr><td>8</td><td>Regularity in Evaluation and Return of Home Assignments</td><td></td><td></td><td></td><td></td><td></td></tr> <tr><td>9</td><td>Regularity in Evaluation and Return of Class tests</td><td></td><td></td><td></td><td></td><td></td></tr> <tr><td>10</td><td>Assessment of students</td><td></td><td></td><td></td><td></td><td></td></tr> </tbody> </table> <p>(II) General Attributes:-</p> <table border="1" style="width: 100%; border-collapse: collapse;"> <thead> <tr> <th>Sr. No.</th> <th>Attribute</th> <th>Excellent</th> <th>V_Good</th> <th>Good</th> <th>Fair</th> <th>Poor</th> </tr> </thead> <tbody> <tr><td>1</td><td>Control of class</td><td></td><td></td><td></td><td></td><td></td></tr> <tr><td>2</td><td>Ability of Motivating students</td><td></td><td></td><td></td><td></td><td></td></tr> <tr><td>3</td><td>Integrity</td><td></td><td></td><td></td><td></td><td></td></tr> <tr><td>4</td><td>Ability to take initiative</td><td></td><td></td><td></td><td></td><td></td></tr> <tr><td>5</td><td>Sense of Humor</td><td></td><td></td><td></td><td></td><td></td></tr> </tbody> </table> <p>(III) Other Considerations:-</p> <p>(i) Would you like to study another subject from the same teacher? YES/NO (ii) Should the same teacher continue to teach this subject to forthcoming batches? YES/NO (iii) What is your overall rating of the teacher on an overall scale of 10?</p>	Sr. No.	Attribute	Excellent	V_Good	Good	Fair	Poor	1	Knowledge of the Subject						2	Way of Teaching / Method of Expression						3	Oral Communication in Class						4	Interaction with students in Tutorial class						5	Experimental skills in Lab Class						6	Use of Teaching Aids						7	Punctuality in class						8	Regularity in Evaluation and Return of Home Assignments						9	Regularity in Evaluation and Return of Class tests						10	Assessment of students						Sr. No.	Attribute	Excellent	V_Good	Good	Fair	Poor	1	Control of class						2	Ability of Motivating students						3	Integrity						4	Ability to take initiative						5	Sense of Humor					
Sr. No.	Attribute	Excellent	V_Good	Good	Fair	Poor																																																																																																																			
1	Knowledge of the Subject																																																																																																																								
2	Way of Teaching / Method of Expression																																																																																																																								
3	Oral Communication in Class																																																																																																																								
4	Interaction with students in Tutorial class																																																																																																																								
5	Experimental skills in Lab Class																																																																																																																								
6	Use of Teaching Aids																																																																																																																								
7	Punctuality in class																																																																																																																								
8	Regularity in Evaluation and Return of Home Assignments																																																																																																																								
9	Regularity in Evaluation and Return of Class tests																																																																																																																								
10	Assessment of students																																																																																																																								
Sr. No.	Attribute	Excellent	V_Good	Good	Fair	Poor																																																																																																																			
1	Control of class																																																																																																																								
2	Ability of Motivating students																																																																																																																								
3	Integrity																																																																																																																								
4	Ability to take initiative																																																																																																																								
5	Sense of Humor																																																																																																																								
11	Grievance redressal mechanism for faculty, staff and students	<p>The feedback from the students is gathered by the HOD/Co-ordinators of the concerned department on his personal basis. Thereafter, the HOD/Co-ordinators prepares cumulative information about the faculty/staff of the department in concern and the said faculty / staff member is informed about the feedback to improve upon his teaching methodology and interaction with the students. The requirements/problems of the faculty/staff members are looked into and the solutions are worked out by the Principal by convening meeting with all the HOD/Co-ordinators.</p>																																																																																																																							
12	Name of the Department (A)	Mechanical Engineering																																																																																																																							
	Course	Mechanical Engineering																																																																																																																							
	Level UG / PG	UG																																																																																																																							
	1st Year of approval by the Council	F.700-20/PB(3)/RC/94 dated 17 th June 1994																																																																																																																							
	Year wise Sanctioned Intake	90 90 60																																																																																																																							
	Year wise Actual Admissions	90+Fee Waiver 90+FeeWaiver 60+Fee Waiver																																																																																																																							
	Cut off marks – General quota	Rank 23237 Rank 19828 Rank 16020																																																																																																																							
	% Students passed with Distinction	02 01 01																																																																																																																							
	% Students passed with First Class	71 54 94																																																																																																																							
	Students Placed	26 24 38																																																																																																																							



Average Pay package, Rs./Year	250000	280000	240000
Students opted for Higher Studies	2	-	-
Accreditation Status of the course	Accredited		
Doctoral Courses	No		
Foreign Collaborations, if any	No		
Professional Society Memberships	Society of Automotive Engg		
Professional activities	Yes		
Consultancy activities	Yes		
Grants fetched	25,00,000		
Departmental Achievements	Highest PhD faculty		
Distinguished Alumni	Siddhartha Sood (L& T InfoTech) & Bhupinder Saini (Infosys)		
Course	Thermal Engineering		
Level UG / PG	PG		
1st Year of approval by the Council	F.765-65/202 (E)/ET/95 dated 13 th July 2007		
Year wise Sanctioned Intake	18	18	18
Year wise Actual Admissions	02	05	01
Cut off marks – General quota	NA	NA	NA
% Students passed with Distinction	NA	NA	NA
% Students passed with First Class	NA	NA	NA
Students Placed	NA	NA	NA
Average Pay package, Rs./Year	NA	NA	NA
Students opted for Higher Studies	NA	NA	NA
Accreditation Status of the course	Not Eligible		
Doctoral Courses	No		
Foreign Collaborations, if any	No		
Professional Society Memberships	Society of Automotive Engg		
Professional activities	Yes		
Consultancy activities	Yes		
Grants fetched	25,00,000		
Departmental Achievements	Highest PhD faculty		
Distinguished Alumni	NA		
Name of the Department (B)	Chemical Engineering & Bio Technology		
Course	Chemical Engineering		
Level UG / PG	UG		
1st Year of approval by the Council	F.765-65/202 (E)/ET/97/341 dated 15 th April 1997		
Year wise Sanctioned Intake	30	30	40
Year wise Actual Admissions	30+Fee Waiver	26	39
Cut off marks – General quota	Rank 22082	Rank 20500	Rank 17777



% Students passed with Distinction	02	02	01
% Students passed with First Class	74	53	86
Students Placed	04	01	10
Average Pay package, Rs./Year	250000	240000	200000
Students opted for Higher Studies	03	05	06
Accreditation Status of the course	Not Accredited		
Doctoral Courses	No		
Foreign Collaborations, if any	No		
Professional Society Memberships	No		
Professional activities	Yes		
Consultancy activities	Yes		
Grants fetched	3,00,000		
Departmental Achievements	Faculty achieved Post Graduate Degree		
Distinguished Alumni	Bharti Chopra (RIL) and Ashish Monga(HLL)		
Course	Bio Technology		
Level UG / PG	UG		
1st Year of approval by the Council	F.765-65/202 (E)/ET/95 dated 27 th July 2006		
Year wise Sanctioned Intake	60	60	60
Year wise Actual Admissions	60+Fee Waiver	60+Fee Waiver	60+Fee Waiver
Cut off marks – General quota	Rank 22088	Rank 21433	Rank 17090
% Students passed with Distinction	NA	NA	NA
% Students passed with First Class	NA	NA	NA
Students Placed	NA	NA	NA
Average Pay package, Rs./Year	NA	NA	NA
Students opted for Higher Studies	NA	NA	NA
Accreditation Status of the course	Not Eligible		
Doctoral Courses	No		
Foreign Collaborations, if any	No		
Professional Society Memberships	No		
Professional activities	Yes		
Consultancy activities	Yes		
Grants fetched	No		
Departmental Achievements	No		
Distinguished Alumni	NA		
Name of the Department (C)	Computer Science & Information Technology		
Course	Computer Science & Engineering		
Level UG / PG	UG		
1st Year of approval by the Council	F.700-20/PB(3)/RC/94 dated 17 th June 1994		



Year wise Sanctioned Intake	90	90	60
Year wise Actual Admissions	90+Fee Waiver	90+Fee Waiver	60+Fee Waiver
Cut off marks – General quota	Rank 18589	Rank 18269	Rank 9071
% Students passed with Distinction	02	02	03
% Students passed with First Class	83	85	95
Students Placed	47	39	36
Average Pay package, Rs./Year	270000	260000	250000
Students opted for Higher Studies	03	3	5
Accreditation Status of the course	Accredited		
Doctoral Courses	No		
Foreign Collaborations, if any	No		
Professional Society Memberships	No		
Professional activities	Yes		
Consultancy activities	Yes		
Grants fetched	90,000		
Departmental Achievements	Faculty achieved Post Graduate Degree		
Distinguished Alumni	Ankush (Satyam) & Manav (L & T InfoTech)		
Course	Information Technology		
Level UG / PG	UG		
1st Year of approval by the Council	F.765-65/202 (E)/ET/95 dated 27 th July 2006		
Year wise Sanctioned Intake	60	60	60
Year wise Actual Admissions	60+Fee Waiver	60+Fee Waiver	60+Fee Waiver
Cut off marks – General quota	Rank 21067	Rank 20126	Rank 12566
% Students passed with Distinction	02	01	03
% Students passed with First Class	90	83	93
Students Placed	20	15	24
Average Pay package, Rs./Year	270000	260000	230000
Students opted for Higher Studies	03	01	-
Accreditation Status of the course	Not Accredited		
Doctoral Courses	No		
Foreign Collaborations, if any	No		
Professional Society Memberships	No		
Professional activities	Yes		
Consultancy activities	Yes		
Grants fetched	No		
Departmental Achievements	-		



Distinguished Alumni	Manav Kundra(L & T InfoTech) & Parul (Satyam)		
Name of the Department (D)	Electronics & Communication Engg		
Course	Electronics & Communication Engg		
Level UG / PG	UG		
1st Year of approval by the Council	F.767-1/5 (E)/ET/97 dated 08 th August 1997		
Year wise Sanctioned Intake	60	60	60
Year wise Actual Admissions	60+Fee Waiver	60+Fee Waiver	60+Fee Waiver
Cut off marks – General quota	Rank 23242	Rank 18978	Rank 9652
% Students passed with Distinction	02	02	04
% Students passed with First Class	91	90	98
Students Placed	48	48	28
Average Pay package, Rs./Year	290000	280000	240000
Students opted for Higher Studies	03	01	05
Accreditation Status of the course	Accredited		
Doctoral Courses	No		
Foreign Collaborations, if any	No		
Professional Society Memberships	No		
Professional activities	Yes		
Consultancy activities	Yes		
Grants fetched	5,00,000		
Departmental Achievements	Faculty achieved Post Graduate Degree		
Distinguished Alumni	Sukhpreet Kaur (Motorola) & Randeep (Satyam)		



13	Name	Dr. Baljinder Kaur Gill	
	Designation	Assistant Professor	
	Department	Chemical Engineering	
	Date of Joining the Institution	05-08-1996	
	Qualifications with Class/Grade	B.E (First Division) M.E (First Division) Ph.D	
	Total Experience in Years	Teaching =10	
	No Papers Published in Journals	National= 01 International=03	
	Papers Presented in Conferences	National= 01 International=02	
	PhD Guide? Give field & University	Nil	
	PhDs / Projects Guided	Projects at Masters Level	
	Books Published / IPRs/ Patents	Nil	
	Professional Memberships	Nil	
	Consultancy Activities	Nil	
	Awards	Nil	
	Grants fetched	Nil	
	Interaction with Professional Institutions:	Panjab University Chandigarh	
	Name	P.K.YADAV	
	Designation	Lecturer (Sr.Scale)	
	Department	Chemical Engg.	
	Date of Joining the Institution	04.09.98	
	Qualifications with Class/Grade	B.Tech, M.Tech	
	Total Experience in Years	Teaching =11	
	No Papers Published in Journals (Attach detail List)	National=NIL International=NIL	
	Papers Presented in Conferences (Attach detail List)	National= 01 International=NIL	
	PhD Guide ? Give field & University	NIL	
	PhDs / Projects Guided	PhDs=NIL Projects at Masters Level: NIL	
	Books Published / IPRs/ Patents	NIL	
	Professional Memberships	Life Member of Indian Society Of Technical Education	
	Consultancy Activities	NIL	
	Awards	NIL	
	Grants fetched	NIL	
	Interaction with Professional Institutions	NIL	

Name of Teaching Staff*	BALJEEV KUMAR	
Designation	Lecturer (Senior Scale)	
Department	Chemical Engineering	
Date of Joining the Institution	21-09-1998	
Qualifications	B.Tech (First Division) M.Tech (First Division)	
Total Experience in Years	Teaching =10 Industry = 09	
Papers Published	National= Nil International=Nil	
Papers Presented in Conferences	National= 01 International=Nil	
PhD Guide. Give field & University	Nil	
PhDs / Projects	Projects at Masters Level	
Books Published / IPRs/ Patents	Nil	
Professional Memberships	ISTE Membership	
Consultancy Activities	Nil	
Awards	Nil	
Grants fetched	Nil	
Interaction with Professional Institutions	CIPET, Amritsar	
Name	SEEMA	
Designation	Lecturer(SS)	
Department	Chemical Engg.	
Date of Joining the Institution	17-07-2000	
Qualifications with Class/Grade	B.Tech Chemical Engg (First division), MSc Biotechnology	
Total Experience in Years	Teaching =15yrs	
No Papers Published in Journals (Attach detail List)	Nil	
Papers Presented in Conferences (Attach detail List)	03	
PhD Guide ? Give field & University	Nil	
Books Published / IPRs/ Patents	Nil	
Professional Memberships	Nil	
Consultancy Activities	Nil	
Awards	Nil	
Grants fetched	Nil	
Interaction with Professional Institutions	Nil	



Name	VIPAN KUMAR	
Designation	Lecturer (Senior Scale)	
Department	Chemical Engineering	
Date of Joining the Institution	17-07-2000	
Qualifications with Class/Grade	B.Tech (First Division) M.Tech (First Division)	
Total Experience in Years	Teaching =10	
No Papers Published in Journals	National= Nil International=02	
Papers Presented in Conferences	National= 05 International=03	
PhD Guide? Give field & University	Nil	
PhDs / Projects Guided	Projects at Masters Level	
Books Published / IPRs/ Patents	One	
Professional Memberships	Bioinformatics Institute of India International Association of Engineer	
Consultancy Activities	Nil	
Awards	Nil	
Grants fetched	Nil	
Interaction with Professional Institutions:	JNU Delhi & IIT Delhi	
Name	MRS. MANIDER PAL	
Designation	Lecturer (Senior Scale)	
Department	Chemical Engineering	
Date of Joining the Institution	16-10-2001	
Qualifications with Class/Grade	B.Tech (First Division)	
Total Experience in Years	Teaching =8	
No Papers Published in Journals	National= 0 International=0	
Papers Presented in Conferences	National= 0 International=0	
PhD Guide? Give field & University	Nil	
PhDs / Projects Guided	Nil	
Books Published / IPRs/ Patents	Nil	
Professional Memberships	Nil	
Consultancy Activities	Nil	
Awards	Nil	
Grants fetched	Nil	
Interaction with Professional Institutions:	Nil	

Name	RAJESH KUMAR SHARMA		
Designation	Lecturer		
Department	Chemical Engineering		
Date of Joining the Institution	11-11-2008		
Qualifications with Class/Grade	B.Tech, M.E (first division)		
Total Experience in Years	Teaching =08		
No Papers Published in Journals	National= 01	International= 00	
Papers Presented in Conferences	National= 01	International= 00	
PhD Guide ? Give field & University	Nil		
PhDs / Projects Guided	Nil		
Books Published / IPRs/ Patents	Nil		
Professional Memberships	life Member of ISTE		
Consultancy Activities	Nil		
Awards	Nil		
Grants fetched	Nil		
Interaction with Professional Institutions	Nil		
Name	AKSHAYE KOHLI		
Designation	Lecturer		
Department	Chemical Engineering		
Date of Joining the Institution	06-01-2010		
Qualifications with Class/Grade	B.Tech		
Total Experience in Years	Teaching =00		
No Papers Published in Journals (Attach detail List)	National= 00	International= 00	
Papers Presented in Conferences (Attach detail List)	National= 00	International= 00	
PhD Guide ? Give field & University	Nil		
PhDs / Projects Guided	Nil		
Books Published / IPRs/ Patents	Nil		
Professional Memberships	Nil		
Consultancy Activities	Nil		
Awards	Nil		
Grants fetched	Nil		
Interaction with Professional Institutions	Nil		

Name	KULJIT KAUR	
Designation	Lecturer	
Department	Chemical Engineering	
Date of Joining the Institution	06-01-2010	
Qualifications with Class/Grade	B.Tech	
Total Experience in Years	Teaching =02	
No Papers Published in Journals (Attach detail List)	National= 00	International= 00
Papers Presented in Conferences (Attach detail List)	National= 00	International= 00
PhD Guide Give field & University	Nil	
PhDs / Projects Guided	Nil	
Books Published / IPRs/ Patents	Nil	
Professional Memberships	Nil	
Consultancy Activities	Nil	
Awards	Nil	
Grants fetched	Nil	
Interaction with Professional Institutions	Nil	
Name	HARSHARAN KAUR	
Designation	Lecturer	
Department	Biotechnology	
Date of Joining the Institution	27-01-2009	
Qualifications with Class/Grade	B.Tech (First division)	
Total Experience in Years	Teaching =1yr	
No Papers Published in Journals	Nil	
Papers Presented in Conferences (Nil	
PhD Guide ? Give field & University	Nil	
Books Published / IPRs/ Patents	Nil	
Professional Memberships	Nil	
Consultancy Activities	Nil	
Awards	Nil	
Grants fetched	Nil	
Interaction with Professional Institutions	Nil	



Name	RAMANPREET KAUR	
Designation	Lecturer	
Department	Biotechnology Deptt.	
Date of Joining the Institution	06-01-2010	
Qualifications with Class/Grade	B.Tech (First division)	
Total Experience in Years	Teaching =1 yr	
No Papers Published in Journals	Nil	
Papers Presented in Conferences	Nil	
PhD Guide ? Give field & University	Nil	
Books Published / IPRs/ Patents	Nil	
Professional Memberships	Nil	
Consultancy Activities	Nil	
Awards	Nil	
Grants fetched	Nil	
Interaction with Professional Institutions	Nil	
	Nil	
Name	SIMARNJIT SINGH	
Designation	Lecturer	
Department	Biotechnology Deptt.	
Date of Joining the Institution	06-01-2010	
Qualifications with Class/Grade	B.Tech (First division)	
Total Experience in Years	Teaching =05 Months	
No Papers Published in Journals	Nil	
Papers Presented in Conferences	Nil	
PhD Guide ? Give field & University	Nil	
Books Published / IPRs/ Patents	Nil	
Professional Memberships	Nil	
Consultancy Activities	Nil	
Awards	Nil	
Grants fetched	Nil	
Interaction with Professional Institutions	Nil	
	Nil	



Name	Dr. Jagmohan Singh	
Designation	Lecturer	
Department	Biotechnology Deptt.	
Date of Joining the Institution	06-01-2010	
Qualifications with Class/Grade	B.Sc, Msc , Ph.D	
Total Experience in Years	Teaching =3yr	
No Papers Published in Journals	03	
Papers Presented in Conferences	Nil	
PhD Guide ? Give field & University	Nil	
Books Published / IPRs/ Patents	Nil	
Professional Memberships	Nil	
Consultancy Activities	Nil	
Awards	Nil	
Grants fetched	Nil	
Interaction with Professional Institutions	Nil	



Name	Arpinder Singh	
Designation	Assistant Professor	
Department	CSE/IT	
Date of Joining the Institution	05-08-1996	
Qualifications with Class/Grade	M.Sc.(H.S) in Mathematics (Ist) M.E. (Computer Sc. Engg.) First with Honours Ph. D Pursuing	
Total Experience in Years	23 years and 2 months	
No Papers Published in Journals	National 01	International Nil
Papers Presented in Conferences	Nil	
PhD Guide? Give field & University	Nil	
PhDs / Projects Guided	Projects at Masters Level	
Books Published / IPRs/ Patents	Nil	
Professional Memberships	Nil	
Consultancy Activities	Nil	
Awards	Nil	
Grants fetched	Rs. 10 lacs From AICTE in MODROB Project	
Interaction with Professional Institutions:	Delivering Expert lectures at GNDU, Amritsar	
Name	SUNIL KUMAR GUPTA	
Designation	Assistant Professor	
Department	CSE/IT	
Date of Joining the Institution	20/08/1996	
Qualifications with Class/Grade	B.E. (Computer sc.) 74.8 % first MS (S/W Systems) CGPA 7.5/10 PhD pursuing	
Total Experience in Years	21 years	
No Papers Published in Journals	National 01	International Nil
Papers Presented in Conferences		
PhD Guide? Give field & University	Nil	
PhDs / Projects Guided	Nil	
Books Published / IPRs/ Patents		
Professional Memberships	ISTE LM	
Consultancy Activities	Nil	
Awards	Nil	
Grants fetched	Rs. 8.10 lacs (from AICTE, new Delhi)	
Interaction with Professional Institutions:		



Name	Dr. Rakesh Chandra Gangwar	
Designation	Assistant Professor	
Department	CSE/IT	
Date of Joining the Institution	12 th June 1995	
Qualifications with Class/Grade	.Tech. (Computer Engg.) 78.12% M.S. (Software Systems) 80.00%	
Total Experience in Years	Teaching Industry Research 16 years 3 years 3 Years	
No Papers Published in Journals	National Nil International 2	
Papers Presented in Conferences		
PhD Guide? Give field & University	Dr. A.K.Sarje, Prof. Network Security I I T, Roorkee	
PhDs / Projects Guided	Projects at Masters Level	
Books Published / IPRs/ Patents	Nil	
Professional Memberships	Life member of ACS, IISC, Bangalore	
Consultancy Activities	Nil	
Awards	Nil	
Grants fetched	Nil	
Interaction with Professional Institutions:	Nil	



Name	Ajay Dogra	
Designation	Assistant Professor	
Department	CSE/IT	
Date of Joining the Institution	17-07-1997	
Qualifications with Class/Grade	B.Tech Computer Engg. 1 st Class	MS(SS) CGPA 8.73
Total Experience in Years	14 Yrs	
No Papers Published in Journals	Nil	
Papers Presented in Conferences	Nil	
PhD Guide? Give field & University	Nil	
PhDs / Projects Guided	Nil	
Books Published / IPRs/ Patents	Nil	
Professional Memberships	Nil	
Consultancy Activities	Nil	
Awards	Nil	
Grants fetched	Nil	
Interaction with Professional Institutions:	Nil	

Name	Sanjeev Mahajan	
Designation	Lecturer (Selection Grade)	
Department	Computer Science and Engineering	
Date of Joining the Institution	07/08/1997	
Qualifications with Class/Grade	B. E. (CSE)	
Total Experience in Years	Teaching – 12 years Industry - 05 Years	
No Papers Published in Journals	National : 02	
Papers Presented in Conferences		
PhD Guide? Give field & University	Nil	
PhDs / Projects Guided	Projects at Masters Level	
Books Published / IPRs/ Patents	Nil	
Professional Memberships		
Consultancy Activities	Nil	
Awards	Best Teacher Award for the session 2006-2007 by Principal	
Grants fetched	Nil	
Interaction with Professional Institutions:		
Name	Sukhbir Singh	
Designation	Lecturer (Senior Scale)	
Department	Computer Science and Engineering	
Date of Joining the Institution	Sept 2, 1998	
Qualifications with Class/Grade	BTech. (Computer Sc. Engg.) First Division M.Tech. Pursuing	
Total Experience in Years	11 years and 5 months	
No Papers Published in Journals	Nil	
Papers Presented in Conferences	Nil	
PhD Guide? Give field & University	Nil	
PhDs / Projects Guided	Nil	
Books Published / IPRs/ Patents	Nil	
Professional Memberships		
Consultancy Activities	Nil	
Awards	Nil	
Grants fetched	Nil	
Interaction with Professional Institutions:	Nil	



Name	Sukhwinder Bir	
Designation	Lecturer	
Department	CSE/IT	
Date of Joining the Institution	17/7/2000	
Qualifications with Class/Grade	UG	
Total Experience in Years	Teaching 9 yaers	
No Papers Published in Journals	Nil	
Papers Presented in Conferences	Nil	
PhD Guide? Give field & University	Nil	
PhDs / Projects Guided	Nil	
Books Published / IPRs/ Patents	Nil	
Professional Memberships		
Consultancy Activities	Nil	
Awards	Nil	
Grants fetched	Nil	
Interaction with Professional Institutions:	Nil	
Name	Guresh Pal Singh	
Designation	Assistant Professor	
Department	Computer Sc. & Engg	
Date of Joining the Institution	9 th March, 2005	
Qualifications with Class/Grade	B.Tech.(First Division) M.Tech (First Division)	
Total Experience in Years	Teaching =12 years	
No Papers Published in Journals	01 (International Journal)	
Papers Presented in Conferences	02 National Conference	
PhD Guide? Give field & University	Nil	
PhDs / Projects Guided		
Books Published / IPRs/ Patents	Nil	
Professional Memberships		
Consultancy Activities	Nil	
Awards	Nil	
Grants fetched	Nil	
Interaction with Professional Institutions:		



Name	Rajeev Bedi	
Designation	Lecturer	
Department	Computer Science and Engineering	
Date of Joining the Institution	14/01/2004	
Qualifications with Class/Grade	M.Tech.(First Division 77%)	
Total Experience in Years	9 years 1 year	
No Papers Published in Journals	National 04	
Papers Presented in Conferences		
PhD Guide? Give field & University	Nil	
PhDs / Projects Guided		
Books Published / IPRs/ Patents	Desktop Publishing Tools(for Distance Education Course)	
Professional Memberships		
Consultancy Activities	Nil	
Awards	Nil	
Grants fetched	Nil	
Interaction with Professional Institutions:		
Name	Anil Sagar	
Designation	Lecturer	
Department	CSE/IT	
Date of Joining the Institution	17-06-2006	
Qualifications with Class/Grade	B.Tech (First Division) M.Tech (IT)	
Total Experience in Years	Teaching = 6	
No Papers Published in Journals	National= 03	
Papers Presented in Conferences		
PhD Guide? Give field & University	Nil	
PhDs / Projects Guided		
Books Published / IPRs/ Patents	Nil	
Professional Memberships		
Consultancy Activities	Nil	
Awards	Nil	
Grants fetched	Nil	
Interaction with Professional Institutions:		

Name	MOHIT MARWAHA	
Designation	LECTURER	
Department	CSE/IT	
Date of Joining the Institution	15 JAN 2009	
Qualifications with Class/Grade	BTECH	MTECH (Pursuing)
Total Experience in Years	1 YEAR	
No Papers Published in Journals	Nil	
Papers Presented in Conferences	Nil	
PhD Guide? Give field & University	Nil	
PhDs / Projects Guided	Nil	
Books Published / IPRs/ Patents	Nil	
Professional Memberships	Nil	
Consultancy Activities	Nil	
Awards	Nil	
Grants fetched	Nil	
Interaction with Professional Institutions:		
Name	Amit	
Designation	Lecturer	
Department	CSE/IT	
Date of Joining the Institution	6 th Jan 2010	
Qualifications with Class/Grade	1 st class (73%)	
Total Experience in Years	Nil	
No Papers Published in Journals	Nil	
Papers Presented in Conferences	Nil	
PhD Guide? Give field & University	Nil	
PhDs / Projects Guided	Nil	
Books Published / IPRs/ Patents	Nil	
Professional Memberships	Nil	
Consultancy Activities	Nil	
Awards	Nil	
Grants fetched	Nil	
Interaction with Professional Institutions:	Nil	

Name	Baljinder Singh	
Designation	LECTURER	
Department	Information Technology	
Date of Joining the Institution	20-Jan-2009	
Qualifications with Class/Grade	B-Tech	M-Tech (Pursuing)
Total Experience in Years	Nil	
No Papers Published in Journals	Nil	
Papers Presented in Conferences	Nil	
PhD Guide? Give field & University	Nil	
PhDs / Projects Guided	Nil	
Books Published / IPRs/ Patents		
Professional Memberships	Nil	
Consultancy Activities	Nil	
Awards	Nil	
Grants fetched	Nil	
Interaction with Professional Institutions:	Nil	
Name	Navneet Kaur	
Designation	LECTURER	
Department	CSE/IT	
Date of Joining the Institution	14/01/2008	
Qualifications with Class/Grade	B-TECH	
Total Experience in Years	2.5 years(app)	
No Papers Published in Journals	Nil	
Papers Presented in Conferences	Nil	
PhD Guide? Give field & University	Nil	
PhDs / Projects Guided	Nil	
Books Published / IPRs/ Patents	Nil	
Professional Memberships	Nil	
Consultancy Activities	Nil	
Awards	Nil	
Grants fetched	Nil	
Interaction with Professional Institutions:	Nil	



Name	HARSIMRAN SINGH	
Designation	LECTURER	
Department	CSE/IT	
Date of Joining the Institution	6- JAN- 2010	
Qualifications with Class/Grade	BTECH	
Total Experience in Years	2.5 YEARS	
No Papers Published in Journals		
Papers Presented in Conferences	Nil	
PhD Guide? Give field & University	Nil	
PhDs / Projects Guided	Nil	
Books Published / IPRs/ Patents	Nil	
Professional Memberships	Nil	
Consultancy Activities	Nil	
Awards	Nil	
Grants fetched	Nil	
Interaction with Professional Institutions:	Nil	
Name	NISHA DHIMAN	
Designation	LECTURER	
Department	CSE/IT	
Date of Joining the Institution	06 JAN 2010	
Qualifications with Class/Grade	BTECH	
Total Experience in Years	Nil	
No Papers Published in Journals	Nil	
Papers Presented in Conferences	Nil	
PhD Guide? Give field & University	Nil	
PhDs / Projects Guided	Nil	
Books Published / IPRs/ Patents	Nil	
Professional Memberships	Nil	
Consultancy Activities	Nil	
Awards	Nil	
Grants fetched	Nil	
Interaction with Professional Institutions:	Nil	



Name	Ravneet Kaur	
Designation	LECTURER.	
Department	Computer Science and Engineering	
Date of Joining the Institution	1-AUG-2008	
Qualifications with Class/Grade	B-TECH	M-TECH (Pursuing)
Total Experience in Years	1.5 years	
No Papers Published in Journals	Nil	
Papers Presented in Conferences	Nil	
PhD Guide? Give field & University	Nil	
PhDs / Projects Guided	Nil	
Books Published / IPRs/ Patents	Nil	
Professional Memberships	Nil	
Consultancy Activities	Nil	
Awards	Nil	
Grants fetched	Nil	
Interaction with Professional Institutions:	Nil	
Name	RICHA DOGRA	
Designation	LECTURER	
Department	CSE/IT	
Date of Joining the Institution	10 Aug, 2010	
Qualifications with Class/Grade	BTECH	M-Tech (Pursuing)
Total Experience in Years	6 Months	
No Papers Published in Journals	Nil	
Papers Presented in Conferences	Nil	
PhD Guide? Give field & University	Nil	
PhDs / Projects Guided	Nil	
Books Published / IPRs/ Patents	Nil	
Professional Memberships	Nil	
Consultancy Activities	Nil	
Awards	Nil	
Grants fetched	Nil	
Interaction with Professional Institutions:	Nil	



Name	Sandeep Kaur		
Designation	LECTURER.		
Department	Computer Science and Engineering		
Date of Joining the Institution	19-Jan-2009		
Qualifications with Class/Grade	B-TECH	M-TECH (Pursuing)	
Total Experience in Years	2.5years		
No Papers Published in Journals	Nil		
Papers Presented in Conferences	Nil		
PhD Guide? Give field & University	Nil		
PhDs / Projects Guided	Nil		
Books Published / IPRs/ Patents	Nil		
Professional Memberships	Nil		
Consultancy Activities	Nil		
Awards	Nil		
Grants fetched	Nil		
Interaction with Professional Institutions:	Nil		
Name	SHAVETA		
Designation	Lecturer		
Department	Information Technology		
Date of Joining the Institution	10 Aug,09		
Qualifications with Class/Grade	B-Tech (IT/First-Div) Pursuing	M-Tech (CSE- Pursuing)	
Total Experience in Years	6 Months		
No Papers Published in Journals	Nil		
Papers Presented in Conferences	Nil		
PhD Guide? Give field & University	Nil		
PhDs / Projects Guided	Nil		
Books Published / IPRs/ Patents	Nil		
Professional Memberships	Nil		
Consultancy Activities	Nil		
Awards	Nil		
Grants fetched	Nil		
Interaction with Professional Institutions:	Nil		



Name	TAJINDER SINGH		
Designation	LECTURER		
Department	CSE/IT		
Date of Joining the Institution	06 JAN 2010		
Qualifications with Class/Grade	BTECH	MTECH (Pursuing)	
Total Experience in Years	6 MONTH		
No Papers Published in Journals	Nil		
Papers Presented in Conferences	Nil		
PhD Guide? Give field & University	Nil		
PhDs / Projects Guided	Nil		
Books Published / IPRs/ Patents	Nil		
Professional Memberships	Nil		
Consultancy Activities	Nil		
Awards	Nil		
Grants fetched	Nil		
Interaction with Professional Institutions:	Nil		



Name	Dr. Dial Chand		
Designation	Professor		
Department	Applied Sciences Hum. & Mgt.		
Date of Joining the Institution	29/05/1995.		
Qualifications with Class/Grade	B.Sc First Division)	M.Sc (First Division) Ph.D	
Total Experience in Years	Teaching =26, Research =04		
No Papers Published in Journals	National= 11	International=17	
Papers Presented in Conferences	National= 03	International=00	
PhD Guide? Give field & University	Yes, Magnetic Thermo Elasticity, H.P. University		
PhDs / Projects Guided	05		
Books Published / IPRs/ Patents	Nil		
Professional Memberships	Yes		
Consultancy Activities	Nil		
Awards	Nil		
Grants fetched	Nil		
Interaction with Professional Institutions:	H.P. University		

Name	Dr. Rajeev Malhotra	
Designation	Asst. Professor	
Department	Applied Sciences Hum. & Mgt.	
Date of Joining the Institution	17/01/2002.	
Qualifications with Class/Grade	M.Sc Physics, M.Phill, Ph.D	
Total Experience in Years	Teaching =11, Research=03	
No Papers Published in Journals (Attach detail List)	National=03 International=04	
Papers Presented in Conferences (Attach detail List)	National= Nil International=Nil	
PhD Guide ? Give field & University	Nil	
PhDs / Projects Guided	Nil	
Books Published / IPRs/ Patents	Nil	
Professional Memberships	Nil	
Consultancy Activities	Nil	
Awards	Nil	
Grants fetched	Nil	
Interaction with Professional Institutions	Nil	
Name of Teaching Staff*	Dr. Rakesh Dogra	
Designation	Asstt. Prof	
Department	Applied Sciences Hum. & Mgt.	
Date of Joining the Institution	11/01/2002.	
Qualifications	M.Sc.(Physics), P.hD.	
Total Experience in Years	Teaching =11 Research = 03	
Papers Published	National= 02 International=28	
Papers Presented in Conferences	National= Nil International=Nil	
PhD Guide. Give field & University	Nil	
PhDs / Projects	Nil	
Books Published / IPRs/ Patents	Nil	
Professional Memberships	Nil	
Consultancy Activities	Nil	
Awards	Nil	
Grants fetched	Nil	
Interaction with Professional Institutions	Australian National University, Australia	



Name	Dr. Sanjay Kumar Srivastava	
Designation	Asstt. Prof.	
Department	Applied Sciences Hum. & Mgt.	
Date of Joining the Institution	12/06/1995.	
Qualifications with Class/Grade	M.Sc., P.hD	
Total Experience in Years	Teaching =12, Research=03	
No Papers Published in Journals	National= 0 International=02	
Papers Presented in Conferences	National= 0 International=02	
PhD Guide? Give field & University	Nil	
PhDs / Projects Guided	Nil	
Books Published / IPRs/ Patents	Nil	
Professional Memberships	Nil	
Consultancy Activities	Nil	
Awards	Nil	
Grants fetched	Nil	
Interaction with Professional Institutions:	Nil	
Name	Dr.Anju Awasthi	
Designation	Asst. Professor	
Department	Applied Sciences Hum. & Mgt.	
Date of Joining the Institution	30/07/1997.	
Qualifications with Class/Grade	M.Sc.(Chemistry), Ph.D	
Total Experience in Years	Teaching =10, Research=03	
No Papers Published in Journals (Attach detail List)	Nil	
Papers Presented in Conferences (Attach detail List)	Nil	
PhD Guide ? Give field & University	Nil	
Books Published / IPRs/ Patents	Nil	
Professional Memberships	Nil	
Consultancy Activities	Nil	
Awards	Nil	
Grants fetched	Nil	
Interaction with Professional Institutions	Nil	

Name	HARVINDER KAUR		
Designation	Lecturer		
Department	Applied Sciences, Hum. & Mgt		
Date of Joining the Institution	27/07/2004.		
Qualifications with Class/Grade	M.sc.(maths), M.Ed		
Total Experience in Years	Teaching =07		
No Papers Published in Journals	National= Nil	International= Nil	
Papers Presented in Conferences	National= Nil	International= Nil	
PhD Guide? Give field & University			Nil
PhDs / Projects Guided			Nil
Books Published / IPRs/ Patents			Nil
Professional Memberships			Nil
			Nil
Consultancy Activities			Nil
Awards			Nil
Grants fetched			Nil
Interaction with Professional Institutions:			Nil
Name	ARVIND KUMAR		
Designation	Lecturer (SS)		
Department	Applied Sciences, Hum. & Mgt.		
Date of Joining the Institution	04/08/1997.		
Qualifications with Class/Grade	M.Sc.(Physics). Ph.D.		
Total Experience in Years	Teaching =10, Research=03		
No Papers Published in Journals	National= Nil	International=14	
Papers Presented in Conferences	National= 14	International=Nil	
PhD Guide ? Give field & University			Nil
PhDs / Projects Guided			Nil
Books Published / IPRs/ Patents			Nil
Professional Memberships			Nil
Consultancy Activities			Nil
Awards			Nil
Grants fetched			Nil
Interaction with Professional Institutions			Nil

Name	SH. JATINDER KUMAR . BEHL		
Designation	Lecturer (S.L Grade)		
Department	Applied Sciences Hum. & Mgt.		
Date of Joining the Institution	06/06/1995.		
Qualifications with Class/Grade	M.A.(English)		
Total Experience in Years	Teaching =24		
No Papers Published in Journals (Attach detail List)	National= 00	International=00	
Papers Presented in Conferences (Attach detail List)	National= 00	International=00	
PhD Guide ? Give field & University			Nil
PhDs / Projects Guided			Nil
Books Published / IPRs/ Patents			Nil
Professional Memberships			Nil
Consultancy Activities			Nil
Awards			Nil
Grants fetched			Nil
Interaction with Professional Institutions			Nil
Name	Rishi Tuli		
Designation	Lecturer		
Department	Applied Sciences, Hum. & Mgt.		
Date of Joining the Institution	30/10/2008.		
Qualifications with Class/Grade	M.Sc. (Maths), M.phil		
Total Experience in Years	Teaching =04		
No Papers Published in Journals	National= 00	International=00	
Papers Presented in Conferences	National= 00	International=00	
PhD Guide ? Give field & University			Nil
PhDs / Projects Guided			Nil
Books Published / IPRs/ Patents			Nil
Professional Memberships			Nil
Consultancy Activities			Nil
Awards			Nil
Grants fetched			Nil
Interaction with Professional Institutions			Nil

Name	Lovejit Kaur	
Designation	Lecturer	
Department	Applied Sciences, Hum. & Mgt.	
Date of Joining the Institution	30/10/2008.	
Qualifications with Class/Grade	M.Sc. (Chemistry)	
Total Experience in Years	Teaching =1yr	
No Papers Published in Journals	Nil	
Papers Presented in Conferences	Nil	
PhD Guide ? Give field & University	Nil	
Books Published / IPRs/ Patents	Nil	
Professional Memberships	Nil	
Consultancy Activities	Nil	
Awards	Nil	
Grants fetched	Nil	
Interaction with Professional Institutions	Nil	
Name	Vishal Mahajan	
Designation	Lecturer	
Department	Applied Sciences, Hum. & Mgt.	
Date of Joining the Institution	31/10/2008.	
Qualifications with Class/Grade	MBA	
Total Experience in Years	Teaching =02	
No Papers Published in Journals	Nil	
Papers Presented in Conferences	Nil	
PhD Guide ? Give field & University	Nil	
Books Published / IPRs/ Patents	Nil	
Professional Memberships	Nil	
Consultancy Activities	Nil	
Awards	Nil	
Grants fetched	Nil	
Interaction with Professional Institutions	Nil	

Name of Teaching Staff*	Dr. O.P. Singh	
Designation	Prof.	
Department	Mechanical Engg.	
Date of Joining the Institution	22.06.1995	
Qualifications	Ph.D, M.E First Honors, B.E. First	
Total Experience in Years	21.5	
Papers Published	National = 07 International=Nil	
Papers Presented in Conferences	National = 02 International=Nil	
PhD Guide. Give field & University	Yes (Operation Research supply chin Design)	
PhDs / Projects	PhDs (02)	
Books Published / IPRs/ Patents	Contributed chapters in two books	
Professional Memberships	Iron (Steel Society Japan	
Consultancy Activities	Nil	
Awards	Best paper Award by SAIL	
Grants fetched	Nil	
Name of Teaching Staff*	Dr. R.K. Awasthi	
Designation	Professor	
Department	Mechanical Engg.	
Date of Joining the Institution	29-11-1996	
Qualifications	Ph.D, B.Tech. (Ist Class), M.E. Ist Class	
Total Experience in Years	19	
Papers Published	National =06 International=Nil	
Papers Presented in Conferences	National = 03 International=Nil	
PhD Guide. Give field & University	Nil	
PhDs / Projects	Nil	
Books Published / IPRs/ Patents	Nil	
Professional Memberships	ISTE, ISME, TSI	
Consultancy Activities	Material Testing Ralated	
Awards	Nil	
Grants fetched	RPS Project for Rs.12 Laks	

Name of Teaching Staff*	Dr. Ranjit Singh	
Designation	A.P.	
Department	Mechanical Engg.	
Date of Joining the Institution	09-11-1995	
Qualifications	Ph.D	
Total Experience in Years	14	
Papers Published	National = 5 International=Nil	
Papers Presented in Conferences	National = 1 International=Nil	
PhD Guide. Give field & University	Solar Energy, PTU	
PhDs / Projects	PhDs (01) Under Guidance Project at Master level (03)	
Books Published / IPRs/ Patents	Nil	
Professional Memberships	SESI, ISTE, PAS	
Consultancy Activities	Nil	
Awards	Nil	
Grants fetched	Nil	
Name of Teaching Staff*	Dr. Dilbag Singh	
Designation	A.P.	
Department	Mechanical Engg.	
Date of Joining the Institution	12-08-1995	
Qualifications	Ph.D. M.Tech (Distinction),B.Tech	
Total Experience in Years	18	
Papers Published	National = 02 International=04	
Papers Presented in Conferences	National = 1 International=05	
PhD Guide. Give field & University	Nil	
PhDs / Projects	Project at Master level (03)	
Books Published / IPRs/ Patents	Nil	
Professional Memberships	ISTE	
Consultancy Activities	Nil	
Awards	Nil	
Grants fetched	Nil	
Interaction with Professional Institutions	IIT Delhi .IIT Roorkee, IIT Kanpur	

Name of Teaching Staff*	Dr. Jagdev Singh	
Designation	A.P.	
Department	Mechanical Engg.	
Date of Joining the Institution	29.08.1997	
Qualifications	Ph.D, M.E & B.E (Mech)	
Total Experience in Years	22 Years	
Papers Published	National (09)	International (10)
Papers Presented in Conferences	National (06)	International (03) (Only one paper presented.)
PhD Guide. Give field & University	(Fuzzy modeling in Engg Systems	
PhDs / Projects	PhDs (02)Guiding	Project at Master level (03)
Books Published / IPRs/ Patents	NIL	
Professional Memberships	ISTE & MIE (India)	
Consultancy Activities	NIL	
Awards	IEI, Best Paper Award.	
Grants fetched	NIL	
Interaction with Professional Institutions	Nil	



Name of Teaching Staff*	Sh. Anil Kumar,	
Designation	A.P.	
Department	Mechanical	
Date of Joining the Institution	16.07.1996	
Qualifications	M.Tech. Ist Class 63%	
Total Experience in Years	13	
Papers Published	National= 2 International =5	
Papers Presented in Conferences	National= Nil International =Nil	
PhD Guide. Give field & University	field (EDM) GGSIP (New Delhi)	
PhDs / Projects	07	
Books Published / IPRs/ Patents	Nil	
Professional Memberships	ISTE Life Member	
Consultancy Activities	Nil	
Awards	Nil	
Grants fetched	10 lakhs RPS F.No 8023/BOR/RID/RPS-129/2007-08. 8.5 laks RPS F.No. 8023/BOR/RID/RPS-144/2008-09	
Interaction with Professional Institutions	Nil	

Name of Teaching Staff*	Sh. Naveen Beri	
Designation	A.P.	
Department	Mechanical Engg.	
Date of Joining the Institution	28.07.1997	
Qualifications	M.Tech.	
Total Experience in Years	12 Years	
Papers Published	National (03) International (04)	
Papers Presented in Conferences	National (01) International (NIL)	
PhD Guide. Give field & University	field (EDM) University(GGSIPU) (Pershing PhD., New Delhi)	
PhDs / Projects	PhDs NIL Project at Master level (07)	
Books Published / IPRs/ Patents	NIL	
Professional Memberships	ISTE (LM25508) Life Member) TSI (4097) (Life Member) JAENG (015573) Member Life)	

Consultancy Activities	NIL
Awards	NIL
Grants fetched	18.5 lakhs
Interaction with Professional Institutions	Nil

Name of Teaching Staff*	Lt. Nirmal Singh		
Designation	A.P		
Department	Mechanical Engg.		
Date of Joining the Institution	01.08.1997		
Qualifications	M.Tech. Ist Class		
Total Experience in Years	13 Years		
Papers Published	National (05)	(06)	International
Papers Presented in Conferences	National (04)	(06)	International
PhD Guide. Give field & University	NIL		
PhDs / Projects	NIL		
Books Published / IPRs/ Patents	NIL		
Professional Memberships	ISTE, New Delhi PAS, Patiala (PB) Tribology Society of India, New Delhi. SAE, USA, & India		
Consultancy Activities	NIL		
Awards	* Uni. First Rankholder doing B.E. * Best Poster in Engg. Section at 6 th Sci. congress at SLIET, Longowal.		
Grants fetched	Rs. 3.00Laks from AICTE		
Interaction with Professional Institutions	NIL		





Name of Teaching Staff*	Darshan Kumar	
Designation	A.P.	
Department	Mechanical Engg.	
Date of Joining the Institution	21.09.1998	
Qualifications	M.Tech. (Ist)	
Total Experience in Years	19 Years	
Papers Published	National International	
Papers Presented in Conferences	National= 05 International	
PhD Guide. Give field & University	Nil	
PhDs / Projects	01	
Books Published / IPRs/ Patents	Nil	
Professional Memberships	ISTE, AMIE, SAE	
Consultancy Activities	Nil	
Awards	Nil	
Grants fetched	Nil	
Interaction with Professional Institutions	Nil	
Name of Teaching Staff*	Sh. Sunil Kumar	
Designation	A.P.	
Department	Mechanical	
Date of Joining the Institution	04.09.1998	
Qualifications	M.Tech.	
Total Experience in Years	12	
Papers Published	National = Nil International=Nil	
Papers Presented in Conferences	National = 02 International=01	
PhD Guide. Give field & University	Nil	
PhDs / Projects	Nil	
Books Published / IPRs/ Patents	Nil	
Professional Memberships	Nil	
Consultancy Activities	Nil	
Awards	Nil	
Grants fetched	Nil	

Name of Teaching Staff*	Sh. Brij Bhushan Saini	
Designation	Lecturer (SS)	
Department	Mechanical	
Date of Joining the Institution	14-09-1998	
Qualifications	M.Tech.(First)	
Total Experience in Years	22	
Papers Published	National = Nil International=01	
Papers Presented in Conferences	National = Nil International=01	
PhD Guide. Give field & University	Nil	
PhDs / Projects	02	
Books Published / IPRs/ Patents	Nil	
Professional Memberships	Member ISTE	
Consultancy Activities	Nil	
Awards	Nil	
Grants fetched	Nil	
Interaction with Professional Institutions	Nil	

Name of Teaching Staff*	Sh.Sarabjit Singh	
Designation	Lecturer(SS)	
Department	Mechanical Engg.	
Date of Joining the Institution	07.08.2001	
Qualifications	M.Tech. (Prod)	
Total Experience in Years	12	
Papers Published	National = 01 International=Nil	
Papers Presented in Conferences	National = 02 International=Nil	
PhD Guide. Give field & University	Nil	
PhDs / Projects	Nil	
Books Published / IPRs/ Patents	Nil	
Professional Memberships	Nil	
Consultancy Activities	Nil	
Awards	Nil	
Grants fetched	Nil	

Name of Teaching Staff*	Sh. Sanjeev Kumar	
Designation	Lecturer (SS)	
Department	Mechanical Engg.	
Date of Joining the Institution	25.01.2002	
Qualifications	M.Tech.	
Total Experience in Years	12	
Papers Published	National = Nil International=Nil	
Papers Presented in Conferences	National = Nil International=Nil	
PhD Guide. Give field & University	Nil	
PhDs / Projects	Nil	

Name of Teaching Staff*	Sh .Simranpreet Singh Gill	
Designation	Lecturer	
Department	Mechanical Engg.	
Date of Joining the Institution	19.05.2005	
Qualifications	M.Tech. / Ist	
Total Experience in Years	5	
Papers Published	National = Nil International=12	
Papers Presented in Conferences	National = 03 International=03	
PhD Guide. Give field & University	Nil	
PhDs / Projects	Nil	
Books Published / IPRs/ Patents	NA	
Professional Memberships	NA	
Consultancy Activities	NA	
Awards	NA	
Grants fetched	MODROBS (20 Lakhs)	



Name of Teaching Staff*	Sh. Munish Kaplas	
Designation	Lecturer	
Department	Mechanical Engg	
Date of Joining the Institution	16.05.2005	
Qualifications	M.Tech. (Prod.) Ist	
Total Experience in Years	07 Years	
Papers Published	National Nil International Nil	
Papers Presented in Conferences	National Nil International 02	
PhD Guide. Give field & University	Nil	
PhDs / Projects	Nil	
Books Published / IPRs/ Patents	Nil	
Professional Memberships	Nil	
Consultancy Activities	Nil	
Awards	Nil	
Grants fetched	Nil	
Interaction with Professional Institutions	Nil	

Name of Teaching Staff*	Sh. Preet Kanwal Singh -	
Designation	Lecturer	
Department	Mechanical Engg.	
Date of Joining the Institution	16-01-2009	
Qualifications	B.Tech	
Total Experience in Years	3.5	
Papers Published	National = Nil International= Nil	
Papers Presented in Conferences	National = Nil International= Nil	
PhD Guide. Give field & University	Nil	
PhDs / Projects	Nil	
Books Published / IPRs/ Patents	01 Patent (Square hole drill Machine)	
Professional Memberships	NA	



Consultancy Activities	NA
Awards	NA
Grants fetched	NA
Name of Teaching Staff*	Sh. Navjot Singh
Designation	Lecturer
Department	Mechanical Engg.
Date of Joining the Institution	06.01.2010
Qualifications	B.Tech.
Total Experience in Years	0.5
Papers Published	National = Nil International= Nil
Papers Presented in Conferences	National = Nil International= Nil
PhD Guide. Give field & University	Nil
PhDs / Projects	Nil
Books Published / IPRs/ Patents	Nil
Professional Memberships	Nil
Consultancy Activities	Nil
Awards	Nil
Grants fetched	Nil



Name of Teaching Staff	Gurpadam Singh	
Designation	Assistant Professor	
Department	Electronics and Communication Engineering	
Date of Joining the Institution	17/7/2000 (27/12/2006 on present post)	
Qualifications	B.E.(1 st Class with Honors)and M.Tech.(1 st class	
Total Experience in Years	14 Years	
Papers Published in Journals	05	
Papers Presented in Conferences	08	
PhD Guide. Give field & University	NA	
PhDs / Projects	Projects: 10	
Books Published / IPRs/ Patents	--	
Professional Memberships	--	
Consultancy Activities	--	
Awards	--	

Grants fetched	--	
Interaction with Professional Institutions	--	
Name	Dr. Amarpal Singh	
Designation	Assistant Professor	
Department	Electronics and Communication Engineering	
Date of Joining the Institution	18-09-1998	
Qualifications with Class/Grade	B.Tech(1 st class), M.E (1 st Class) and PhD	
Total Experience in Years	Teaching =16	
No Papers Published in Journals	National= 21	International=05
Papers Presented in Conferences	National= 04	International=13
PhD Guide? Give field & University	Field: Optical Communication University: PTU Jalandhar	
PhDs / Projects Guided	PhDs=06 guiding	
Books Published / IPRs/ Patents	--	
Professional Memberships	Member of Institution of Engineers (India)	
Consultancy Activities	--	
Awards	--	
Grants fetched	STTP (AICTE sponsored) Received grant 90,000/-	
Interaction with Professional Institutions:	---	
Name	Parveen Kumar	
Designation	Assistant Professor	
Department	Electronics & Communication Engg.	
Date of Joining the Institution	11/09/1998	
Qualifications with Class/Grade	B.Tech. (1 st Class) and M.Tech (1 st Class)	
Total Experience in Years	15 yrs(Teaching)	

No Papers Published in Journals	02
Papers Presented in Conferences	02
PhD Guide ? Give field & University	NA
PhDs / Projects Guided	NA
Books Published / IPRs/ Patents	--
Professional Memberships	--
Consultancy Activities	--
Awards	--
Grants fetched	--
Interaction with Professional Institutions	--
Name	Jaswinder Singh
Designation	Assistant Professor
Department	Electronics & Communication Engg.
Date of Joining the Institution	17.07.1996
	
Qualifications with Class/Grade	Batch. and M.Tech.(1 st class) PhD (Pursuing)
Total Experience in Years	14 years
No Papers Published in Journals	05(International)
Papers Presented in Conferences	03(International)
PhD Guide ? Give field & University	--
PhDs / Projects Guided	Projects : 06
Books Published / IPRs/ Patents	--
Professional Memberships	--
Consultancy Activities	--
Awards	--
Grants fetched	--
Interaction with Professional Institutions	--
	--

Name	Ajay Kumar	
Designation	Assistant Professor	
Department	Electronics & Comm. Engg	
Date of Joining the Institution	18-7-1996	
Qualifications with Class/Grade	B.E. (1 st Class) and M.Tech (1 st Class), PhD (perusing)	
Total Experience in Years	14 Years	
No Papers Published in Journals	National = 03 International = 07	
Papers Presented in Conferences	National = 04	
PhD Guide? Give field & University	--	
PhDs / Projects Guided	--	
Books Published / IPRs/ Patents	--	
Professional Memberships	Life Member of ISTE	
Consultancy Activities	--	
Awards	--	
Grants fetched	--	
Interaction with Professional Institutions:	--	
Name	Neetu	
Designation	Lecturer (Senior scale)	
Department	Electronics & Communication Engg.	
Date of Joining the Institution	26/07/2007	
Qualifications with Class/Grade	B.Tech.(ECE)	
Total Experience in Years	13 Years	
No Papers Published in Journals	01	
Papers Presented in Conferences	--	
PhD Guide ? Give field & University	--	
PhDs / Projects Guided	--	

Books Published / IPRs/ Patents	--	
Professional Memberships	--	
Consultancy Activities	--	
Awards	--	
Grants fetched	--	
Name	Mandeep Kaur Sekhon	
Designation	Lecturer (Sr. Scale) W/P ECE	
Department	Electronics and Communication Engineering	
Date of Joining the Institution	10/4/2002 (18/10/2007 on present post)	
Qualifications with Class/Grade	B.E.(1 st class) and M.E.(1 st Class)	
Total Experience in Years	14 Years	
No Papers Published in Journals	--	
Papers Presented in Conferences	--	
PhD Guide ? Give field & University	--	
PhDs / Projects Guided	--	
Books Published / IPRs/ Patents	--	
Professional Memberships	--	
Consultancy Activities	--	
Awards	--	
Grants fetched	--	
Interaction with Professional Institutions	--	
Name	Anita Suman	
Designation	Lecturer	
Department	Electronics & Communication Engg.	
Date of Joining the Institution	28/07/2004	
Qualifications with Class/Grade	B.Tech.(1 st Class) and M.Tech. (1 st Class)	

Total Experience in Years	9 Years
No Papers Published in Journals	02
Papers Presented in Conferences	02
PhD Guide ? Give field & University	
PhDs / Projects Guided	Projects at Masters Level: 05
Books Published / IPRs/ Patents	--
Professional Memberships	--
Consultancy Activities	--
Awards	--
Grants fetched	--
Interaction with Professional Institutions	--
	--
Name	Gurpreet Kaur
Designation	Lecturer
Department	Electronics and Communication Engineering
Date of Joining the Institution	6-01 2010
Qualifications with Class/Grade	B.Tech.(1 st Class), M.Tech(Pursuing)
Total Experience in Years	Six Months
No Papers Published in Journals	--
Papers Presented in Conferences	--
PhD Guide ? Give field & University	--
PhDs / Projects Guided	--
Books Published / IPRs/ Patents	--
Professional Memberships	--
Consultancy Activities	--
Awards	--
Grants fetched	--
Interaction with Professional Institutions	--



Name	Mandeep Kaur Minhas		
Designation	Lecturer		
Department	Electronics and Communication Engineering		
Date of Joining the Institution	6-01 2010		
Qualifications with Class/Grade	B.Tech.		
Total Experience in Years	Six Months		
No Papers Published in Journals	--		
Papers Presented in Conferences	--		
PhD Guide ? Give field & University	--		
PhDs / Projects Guided	--		
Books Published / IPRs/ Patents	--		
Professional Memberships	--		
Consultancy Activities	--		
Awards	--		
Grants fetched	--		
Interaction with Professional Institutions	--		

14	Admission quota	85% for Punjab State & 15 % for Other States		
	Entrance test / admission criteria	CET / AIEEE		
	Cut off / last candidate admitted	23242/726530	21433/773388	17777/574887
	Fees in rupees (Tuition Fee)	22500	22500	22500
	Number of Fee Waivers offered	24	27	-
	Admission Calendar	8 th June -6 Aug 2009	15 th June -12 Aug 2008	6 th June -10 Aug 2007
	PIO quota	NO		
15	Infrastructural information^	Yes		

Classroom/Tutorial Room facilities

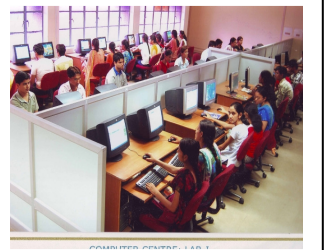
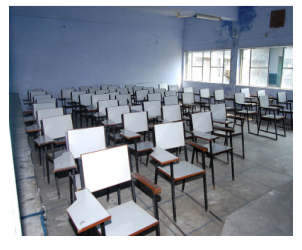
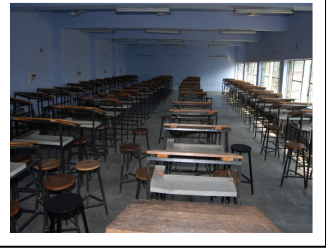

Laboratory details



Computer Centre facilities



Library facilities



<p>Auditorium* / Seminar Halls</p>	 <p>*Under Construction</p>
<p>Cafeteria</p>	
<p>Indoor Sports facilities</p>	
<p>Outdoor Sports facilities</p>	
<p>Gymnasium facilities</p>	

	Facilities for disabled	--
	Any other facilities	 
16	Boys Hostel	 
	Girls Hostel	
	Medical & other Facilities at Hostel	
17	Academic Sessions	Odd Sem (Aug-Dec) & Even Sem (Jan-May)
	Examination system	Semester
	Period of declaration of results	2months
18	Counseling / Mentoring	Student Advisors have been nominated at department Level

	Career Counseling	Through Training & Placement
	Medical facilities	Available in College Dispensary
	Student Insurance	Yes
19	Students Activity Body	Available in College Campus
	Cultural activities	Fine Arts, Music & Dramatic and Punjab Sabyacharak Club
	Sports activities	Table Tennis, Badminton , Basket Ball, Cricket & Lawn Tennis
	Literary activities	Literary Society
	Magazine / Newsletter	College Magazine twice a year
	Technical activities / Tech Fest	ISTE Student Chapter and SAE, Tech-Fest (Annually)
	Industrial Visits / Tours	Yes
	Alumni activities	Once a Year
20	Name of the Information Officer for RTI	Inder Pal Singh
	Designation	Registrar
	Phone number with STD code	01874-21537
	FAX number with STD code	01874-221464
	Email	ipsingh.adm@bcetgsp.ac.in

CAY=Current Academic Year

*Repeat this template for each department / staff.

#Repeat this template for additional quota, if any.